



RBA
RELIEF BED WHOLESAL

ABOUT OUR FOUNDER

The creation of Relief Bed Wholesale has been a dream of mine for many years. I desired to use my 25 years as a manufacturer and innovator in the furniture and bedding industry to create a company that could in part act as a funding mechanism for the non-profit organization I started in 2015 called Relief Bed International. Relief Bed International is a 501c 3 Non-profit which supplies beds, pads and sleeping mats to disaster relief projects worldwide and in support of homeless shelters in the USA. To date Relief Bed® has distributed/donated more than 30,000 beds, pads and mats directly and in cooperation with its corporate partners. Most recently, Relief Bed International donated 1,000 beds to support humanitarian efforts in the Ukraine and also donated 500 beds to support recovery efforts from the devastating earthquakes in Turkey and Syria. For more information about Relief Bed International please visit www.reliefbed.org

Our goal with Relief Bed Wholesale is to initially dedicate 10% of our net revenue from each sale towards building beds to distribute through Relief Bed International. This way Relief Bed International will have a steady inflow to continue its work world-wide. We hope to include other charitable partners as we grow.

Our overall mission is to provide Relief to You through a rejuvenating nights rest and Relief to the World by providing those displaced by natural disaster or experiencing homelessness with a bed.

I hope you enjoy the collection of sleep and furniture products we have put together.

Scott Smalling
Founder



TABLE OF CONTENTS

01	WHY RELIEF BED WHOLESALE
02	GLOBAL RELIEF BED PROJECTS
03	MATTRESSES
04	ADJUSTABLE POWER BASES
05	BED FRAMES
06	BEDROOM FURNITURE
07	PILLOWS
08	BED LINENS & ACCESSORIES
09	SEATING

WHY RELIEF BED WHOLESAL?

At Relief Bed Wholesale we have worked hard to curate a fantastic and exhaustive line of sleep and furniture products as well as keeping our prices as low as possible with some of our products comparable to others at almost twice the price. We achieve this by having very low overhead, reasonable margins, no expensive advertising budgets, no gimmicks (which cost money to support) and lastly a small, passionate and nimble team who are mission focused. As we embark on this journey we can assure you that we will continue to push the envelope on product offerings, unique and thoughtful marketing campaigns and we will be calling on the biggest untapped resource in the market.

Stay Tuned!



GIVING BACK

Relief Bed Wholesale is a business with a mission. Our plan is to donate 10% of the net revenue from every sale. Our main partner will initially be Relief Bed International, but we plan on expanding to other non-profit partners which will provide you a choice of where your donation will go.

The following pages share some of Relief Bed Internationals projects over the last 8 years.

During COVID Relief Bed International dedicated resources, created assembly areas and time to build face shields for care givers. Scott Smalling called on his children Hunter and Sharky along with his Father Jay to help build hundreds of face shields.

GLOBAL RELIEF BED PROJECTS



KAMPALA, UGANDA ORPHANAGE PROJECT 2015

Sent 30 Relief Beds to Orphanage in Uganda. Another partner made steel bunk beds to house the Relief Beds. These children had only slept on the ground prior. Remember your joy as a child on a bunk bed, now triple it.



2017 PUEBLA, MEXICO EARTHQUAKE

In collaboration with the organization Giving Children Hope - Relief Bed International donated hundreds of beds to help those displaced by the earthquake.

4TH OF JULY CELEBRATION 2017

Relief Bed Team and volunteers built a mobile kitchen and served a holiday picnic in two locations to approximately 50 homeless friends in Tacoma, WA

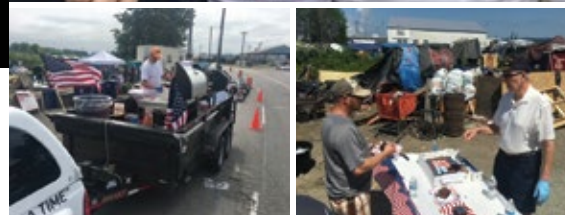

TACOMA, WA SHELTER

Relief Bed partnered with the City of Tacoma and donated 100 Relief Beds for their new Emergency Shelter facility.

2021



PROJECT MEXICO & USA

RELIEFBED



Relief Bed International in partnership with World Vision has donated hundreds of Relief Beds in recent years to assist with World Vision's work at the Mexico / USA border for emergency sheltering and for disaster relief efforts in the USA.



RELIEFBED

PROJECT TURKEY & SYRIA

Relief Bed International partnered again with Convoy of Hope to air ship 500 beds to support those affected by the devastating earthquakes in Turkey and Syria.



2023

RELIEFBED

Shortly after the beginning of the war in Ukraine we started reaching out to organizations to partner with, in country, to support those displaced by the war.

We are thrilled to have partnered with Convoy of Hope and World Vision with a donation of 1,000 beds. A special Thank You to all of those who supported this project!



UKRAINE PROJECT 2022

2023

PROJECT MAUI, HI

RELIEFBED

MAUI WILDFIRES RESPONSE. Relief Bed International in partnership with World Vision donated 100 Relief Beds to support the recovery and rebuilding efforts in Maui, HI.



MATTRESSES

With a quality Mattress being the cornerstone of a good nights sleep, I made sure that it was the first product selection in this catalog. Through decades of mattress manufacturing and innovating I made sure to offer just enough mattresses to provide you a choice, but not so many that it will be confusing. All 6 of our mattresses come in a medium/medium firm support. I strongly believe this is the best level of support for most sleepers in order to achieve your best sleeping posture. Our 2 premium ALL FOAM, memory foam, mattresses provide a very stable and conforming comfort along with our value priced 6" ALL FOAM Mattress. Our 3 premium HYBRID, memory foam and latex, mattresses provide a little more resilience and movement on the mattress if this is your preference.

All premium mattresses come with a 10 year warranty.



14" COOLSYNC

MATTRESS

- Ultra-plush CoolSync™ foam gently contours the body and balances sleep temperature with a gel infusion
 - 14-inch profiles include a plush base foam layer to increase comfort and help evenly distribute weight
 - Ventilated design in top layer of CoolSync™ foam optimizes air flow and boosts temperature regulation
 - Quilted jacquard cover keeps everything in place and offers a plush, breathable sleep surface
 - Supportive base foam provides a solid foundation that remains flexible for use with an adjustable bed base
 - Foam is CertiPUR-US® certified to meet the highest standards
- 10 YEAR WARRANTY**



Soft Jacquard Cover

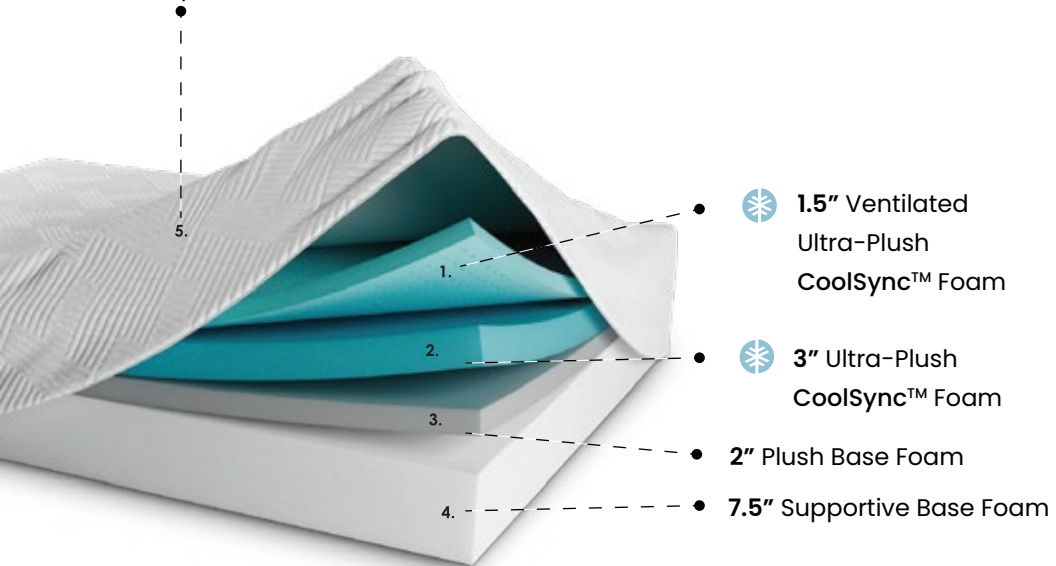

SIZES

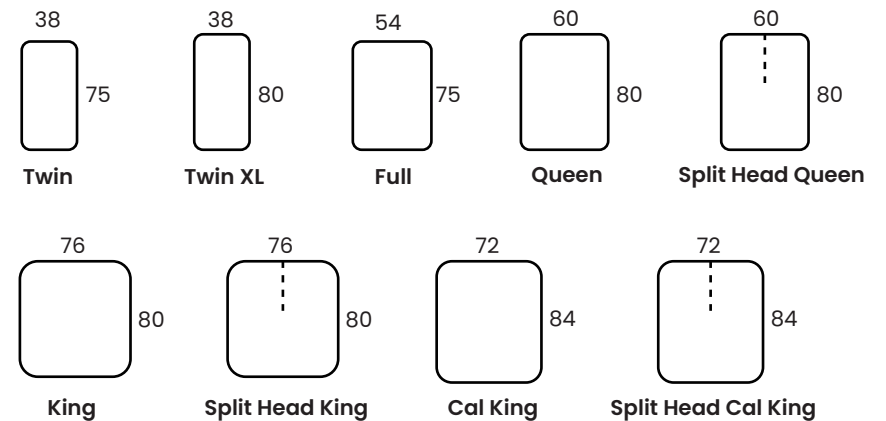



11" COOLSYNC

MATTRESS

- Ultra-plush CoolSync™ Cooling foam gently contours the body and balances sleep temperature with a gel infusion
- 11 inch profiles include a plush base foam layer to increase comfort and help evenly distribute weight
- Ventilated design in top layer of CoolSync™ Foam optimizes air flow and boosts temperature regulation
- Quilted jacquard cover keeps everything in place and offers a plush, breathable sleep surface
- Supportive base foam provides a solid foundation that remains flexible for use with an adjustable bed base
- Foam is CertiPUR-US® certified to meet the highest standards

10 YEAR WARRANTY

SIZES

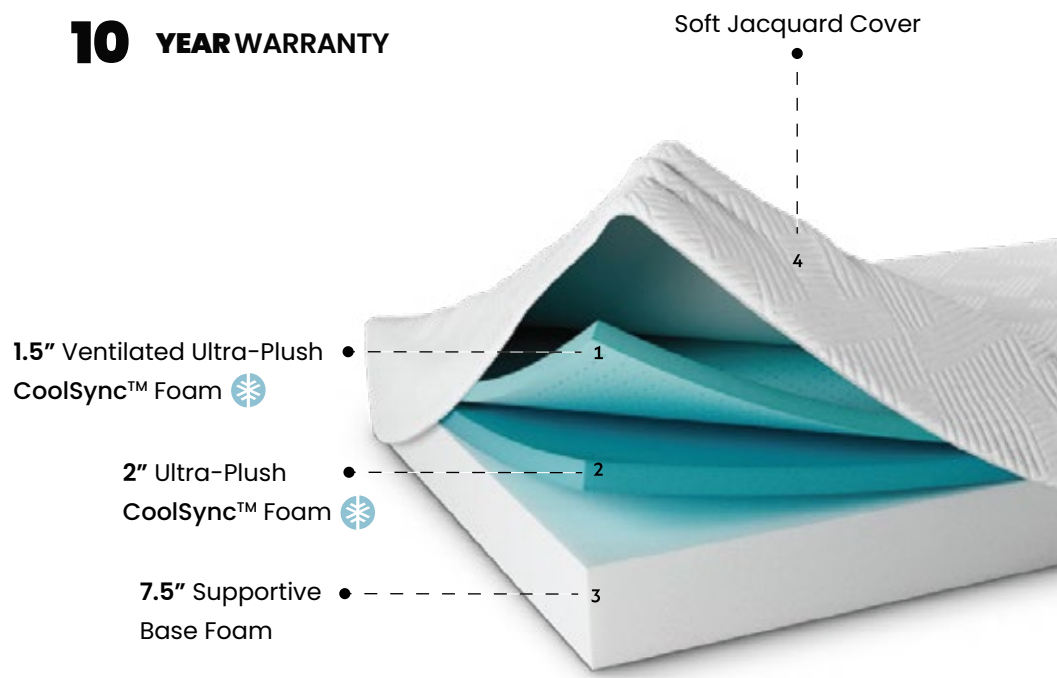
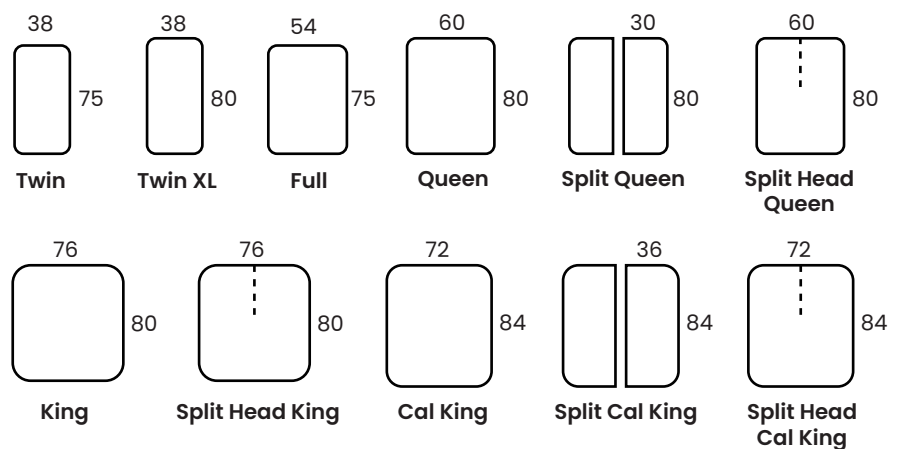

14" COOLSYNC HYBRID WITH HYPERCHILL MATTRESS

- Ultra-plush CoolSync™ foam has a gel infusion, providing a soft cushion that contours the body and balances sleep temperature
- AltiCoil™ comfort layer is super responsive, with hundreds of miniature individually-encased steel coils made to compress and expand for targeted pressure relief
- Another layer of CoolSync™ foam adds extra cooling power and pressure relief
- Foam is CertiPUR-US® certified to meet the highest standards
- An additional layer of individually-encased steel coils absorbs and isolates motion, creating an extremely strong core of support
- Supportive base foam provides a stable foundation while still remaining flexible for use with an adjustable bed base
- Cooling HyperChill cover is cool to the touch, offsetting excess body heat

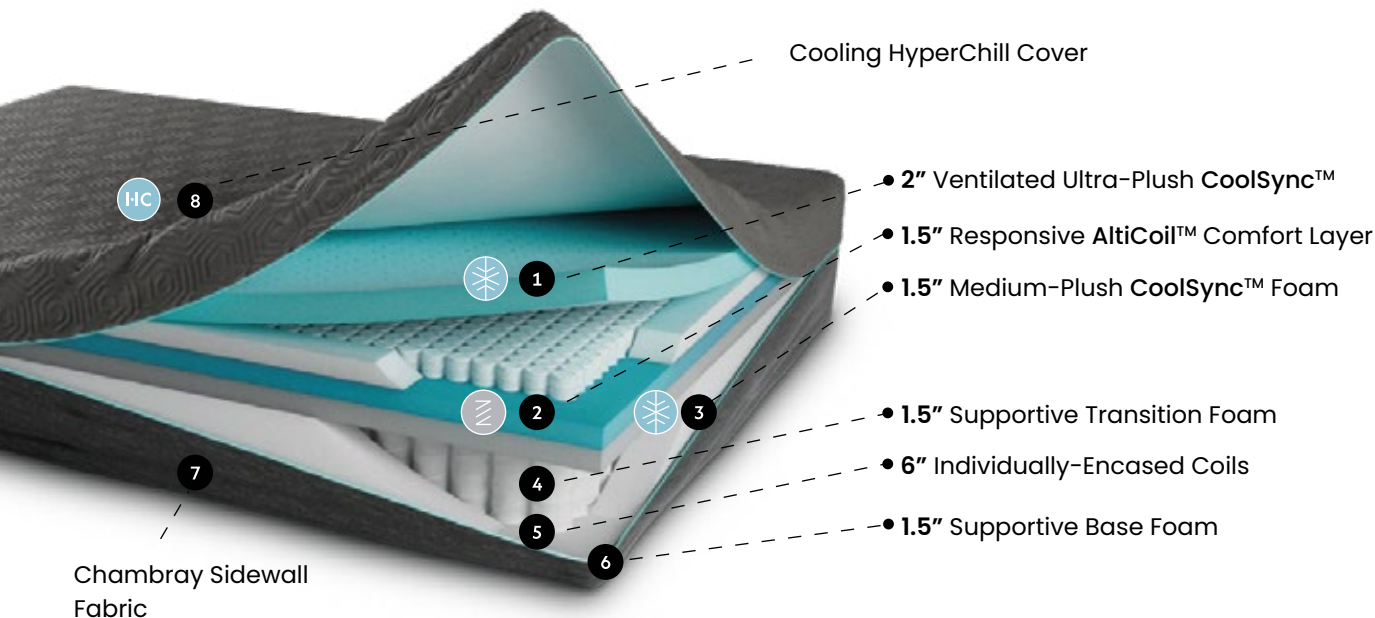

SIZES

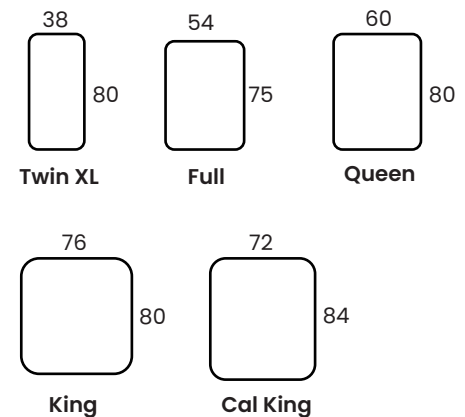

10 YEAR WARRANTY



14" COOLSYNC HYBRID MATTRESS

- Ultra-plush CoolSync™ foam has a gel-infusion and ventilated design, providing a soft cushion that contours the body and balances sleep temperature
- 14-inch profiles feature a medium-plush layer of CoolSync™ foam for extra cooling power and pressure relief
- Chambray sidewall fabric adds softness and a luxurious look and feel from all sides
- Foam is CertiPUR-US® certified to meet the highest standards
- Supportive base foam provides a stable foundation while still remaining flexible for use with an adjustable bed base
- Individually-encased steel coils absorb and isolate motion, creating an extremely strong core of support
- Quilted jacquard cover keeps everything in place and offers a plush, breathable sleep surface

SIZES

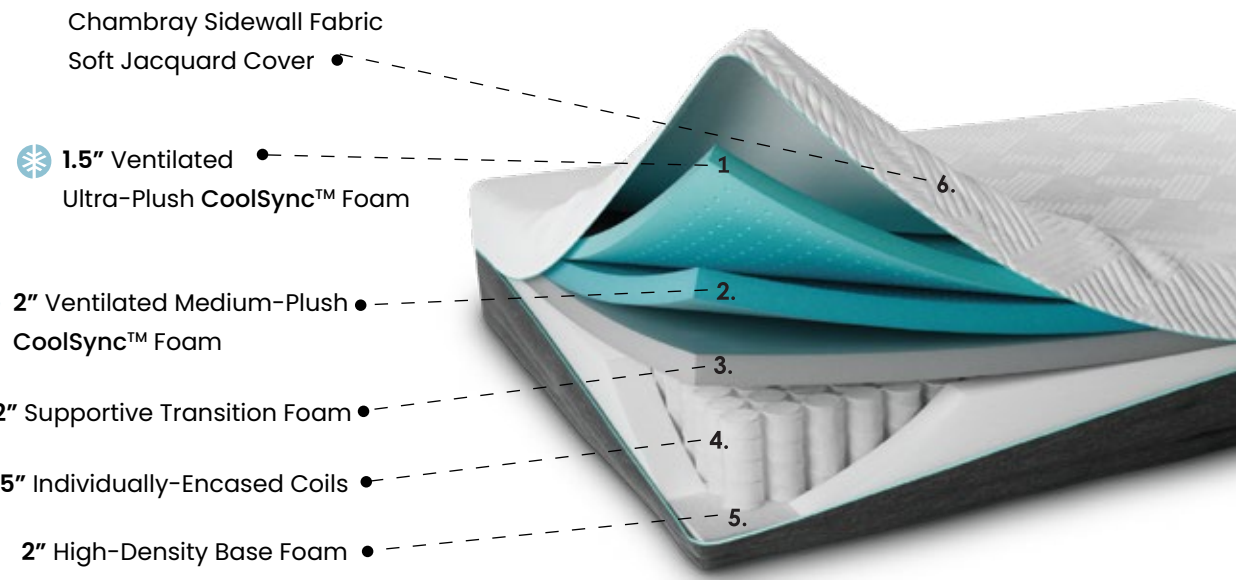
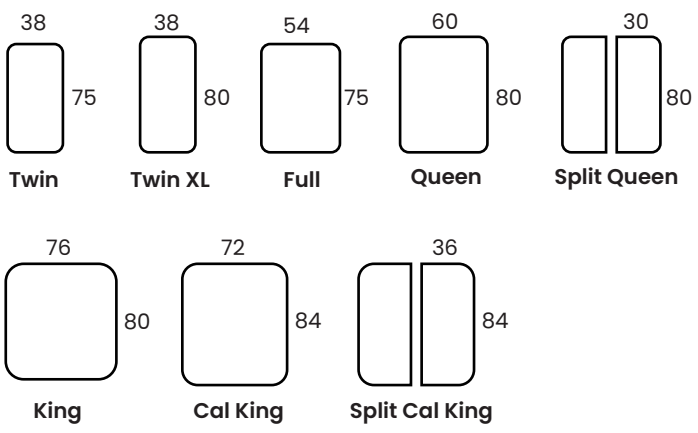

10 YEAR WARRANTY

11" AEROFLEX™ HYBRID MATTRESS

- Ventilated AeroFlex™ layer is made of premium latex, with a super breathable and quick-response feel that offers firm support while lightly contouring the body
- Ultra-plush CoolSync™ foam has a gel infusion, offering additional contouring and pressure relief, while simultaneously balancing sleep temperature
- Individually-encased steel coils absorb and isolate motion, creating an extremely strong core of support
- Supportive base foam provides a stable foundation while still remaining flexible for use with an adjustable bed base
- Chambray sidewall fabric adds softness and a luxurious look and feel from all sides
- Quilted jacquard cover keeps everything in place and offers a plush, breathable sleep surface
- Foam is CertiPUR-US® certified to meet the highest standards

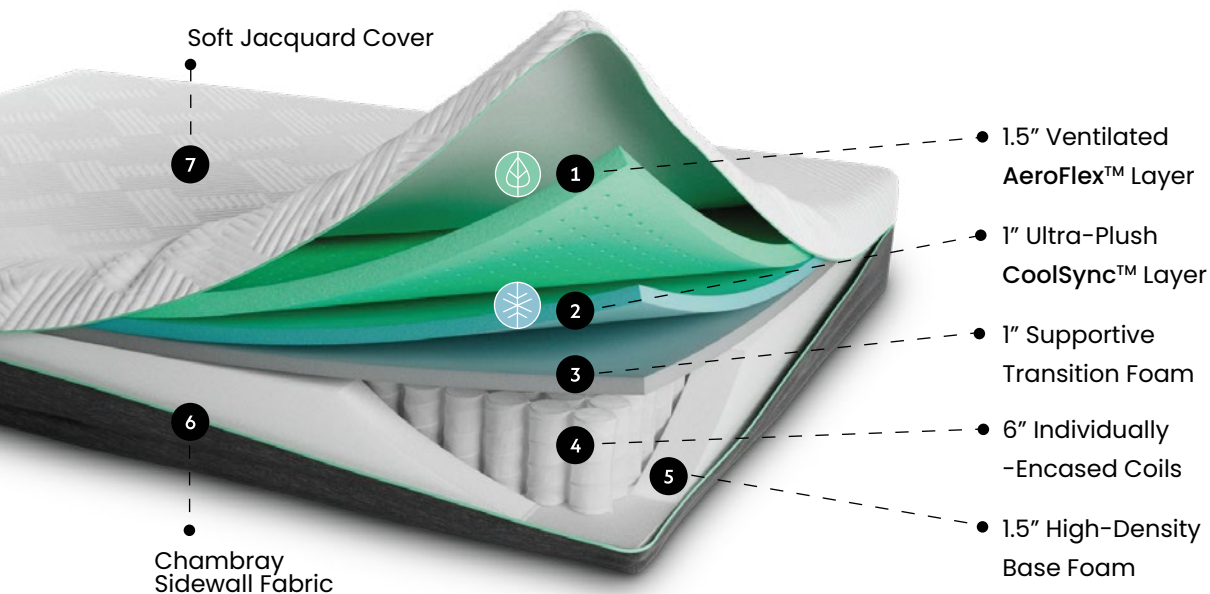

SIZES

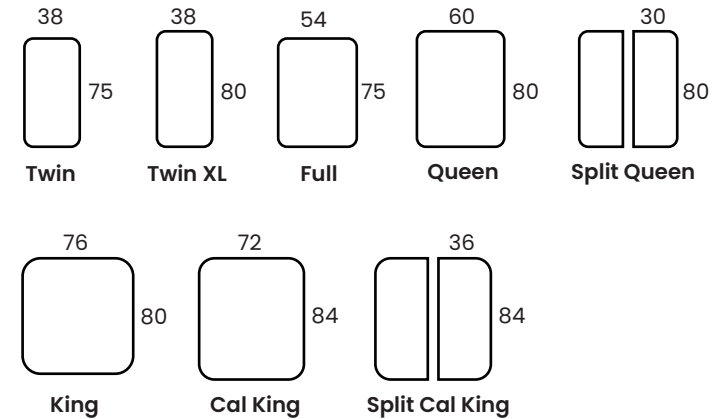

10 YEAR WARRANTY

BASIC - 6"

MATTRESS

- Waterproof removeable cover in attractive gray velour
- 1.5 inch top layer of gel-infused memory foam regulates temperature
- Memory foam layer conforms to the body and helps reduce motion transfer
- Non-slip base keeps mattress secure and prevents movement

3 YEAR WARRANTY



SIZES

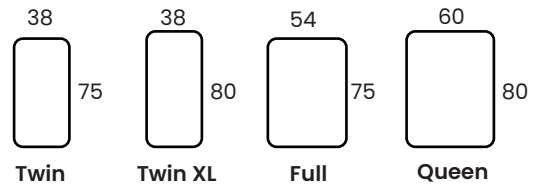



ADJUSTABLE POWER BASES

Don't knock it until you try it. Having an adjustable power base under your mattress is a game changer. For decades the sole purpose of a standard foundation (boxspring) has had one purpose, to raise the mattress up a little higher off the ground to make getting in and out of bed easier. That's all it does. Choosing a Power Base for only a few hundred dollars more will transform your sleep experience. Power bases can help with a myriad of sleep related health issues like snoring, acid reflux, raising your legs for better circulation or for recovering from a leg or ankle injury and more. It also allows you to easily read, watch tv and DINE IN without having to build a pyramid of pillows behind you. This is just the beginning. Over the years I have sold thousands of power bases through my different companies and I don't remember many people ever saying I wish I had bought the standard foundation. Its quite the opposite. Most of our bases come with a zero gravity position which is just, "other worldly."



BASIC SERIES

ADJUSTABLE POWER BASE

- Independent head incline: 0–58°
- 14-inch height from floor to top of base
- Set up in 15 minutes from start to finish
- 600-pound weight capacity on all sizes
- Zero clearance
- Wired Remote Control
- Folds in half for easy FedEx and UPS shipping
- Upholstered in two-tone black color

5 YEAR WARRANTY

SIZES

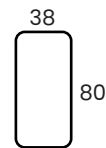

Twin XL

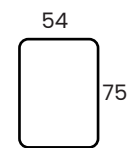

Full

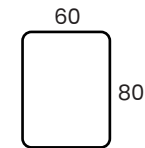

Queen

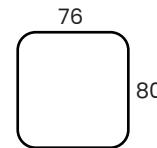

King

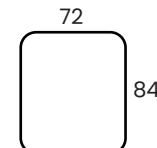

Cal King





3 SERIES

ADJUSTABLE POWER BASE

- Independent head incline: 0–58°
- Independent foot incline: 0–40°
- 14-inch height from floor to top of base; includes 12-inch legs; modular legs available in additional sizes
- Lightweight, durable metal frame with black finish
- Wired Remote Control
- Folds in half for easy FedEx and UPS shipping
- 650-pound weight capacity on both sizes
- Set up in 15 minutes from start to finish

SIZES

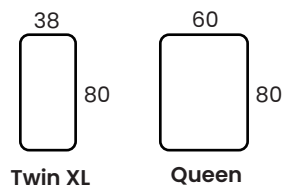
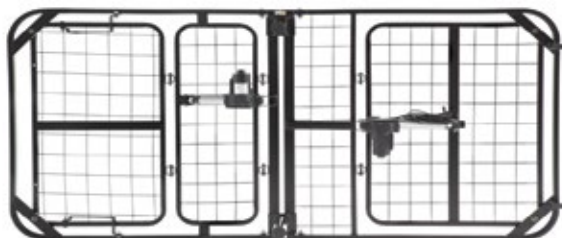

5 YEAR WARRANTY

4 SERIES

SMART ADJUSTABLE BED BASE

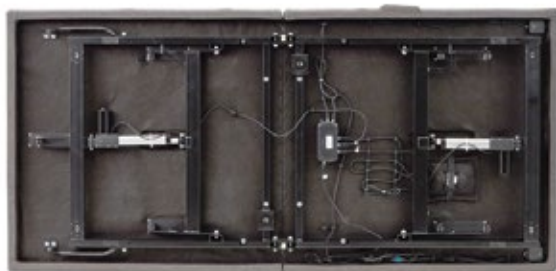

- Independent head incline: 0 – 60°, foot incline: 0 – 45°
- 15-inch height from floor to top of base; includes 3", 3", 6" legs; modular legs available in additional sizes
- Backlit, wireless remote control, batteries included
- Two preset positions: Zero Gravity and Flat
- One programmable position can be customized and saved
- True zero clearance; remove the legs to place directly on foundations, platform bases, slat beds, or ground (now includes slat stabilizer brackets)
- Set up in 15 minutes from start to finish
- Dual 5V 1.5A charging ports located on both sides of base
- Zoned neck and back massage with three intensities
- Bluetooth® with the highest-rated and industry-leading App; Siri® Shortcut voice commands and automatic snore detection available
- Headboard brackets and other leg sizes available upon request
- Upholstered in linen-inspired fabric
- 850-pound weight capacity on all sizes
- All sizes foldable for easy storage; Twin XL and Split California King can be shipped by FedEx and UPS

SIZES

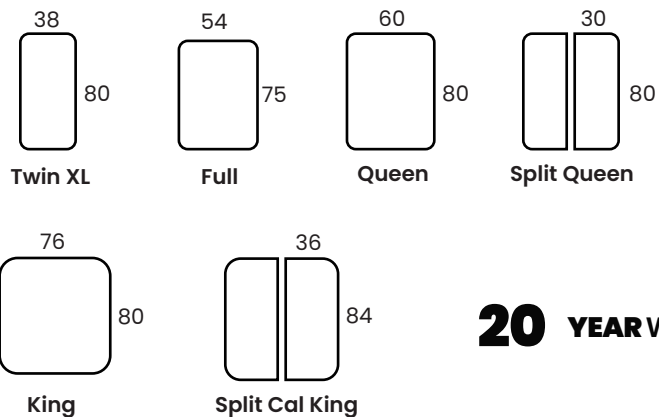

20 YEAR WARRANTY

5 SERIES

SMART ADJUSTABLE BED BASE



- Independent head incline: 0 – 60°, foot incline: 0 – 45°
- 15-inch height from floor to top of base; includes 3", 3", 6" legs; modular legs available in additional sizes
- LED Backlit, wireless remote control, batteries included
- Five preset positions: **Zero Gravity, Anti-Snore, Lounge, TV, and Flat**
- Five programmable positions can be customized and saved
- True zero clearance; remove the legs to place directly on foundations, platform bases, slat beds, or ground (now includes slat stabilizer brackets)
- Dual 5V 1.5A charging ports located on both sides of base
- 12 dual-zone massage options: 4 types, 3 intensities with 3 time settings
- Bluetooth® with the highest-rated and industry-leading App; Siri® Shortcut voice commands and automatic snore detection available
- Underbed LED nightlights
- Set up in 15 minutes from start to finish
- Headboard brackets and other leg sizes available upon request
- Upholstered with linen-inspired fabric in Stone color
- Child-lock safety feature
- All sizes foldable for easy storage; Twin, Twin XL, Split Queen, and Split California King can be shipped by FedEx and UPS
- 850-pound weight capacity on all sizes

SIZES

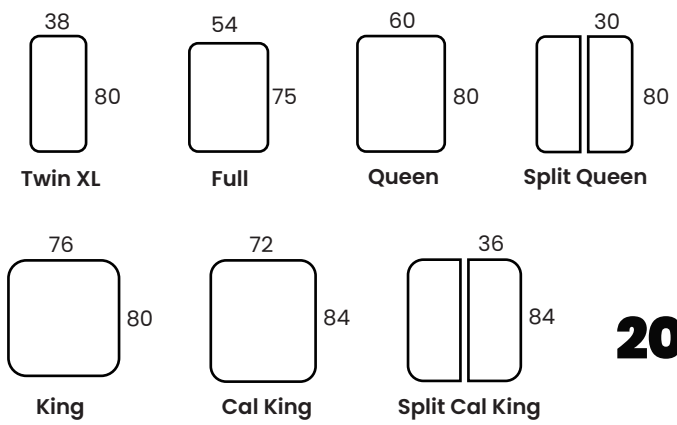

20 YEAR WARRANTY

BED FRAMES

There are multiple styles of bed frames. Some are low to the ground with wheels or legs and their sole purpose is to hold/support a standard foundation (box spring). Other bed frames are called platform bases and they serve several purposes. They bring the mattress high enough off the floor so there is no need for a standard foundation. They have a fully supported surface to place your mattress. Most platform bases also create great usable space for storage.



BED FRAMES

CONTEMPORARY PLATFORM BED FRAME



- Features a metal frame and brushed, matte black finish
- Sturdy steel legs and frame with 12 inches of underbed storage
- Fits most headboards and includes headboard slots
- Slat platform provides even mattress support; no box spring required
- Easy assembly with all hardware included

5 YEAR WARRANTY

SIZES

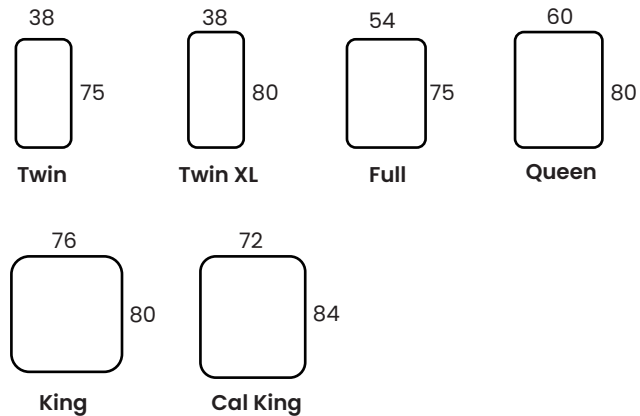





HIGHRISE™ LT

BED FRAME

- Eliminates the need for a box spring
- 13 inches of clearance creates up to 45 cubic feet of storage space
- Now with easier assembly—new tightening system requires no additional tools or hardware
- Folded and boxed for easy storage and transport
- 500-pound weight capacity

5 YEAR WARRANTY



SIZES

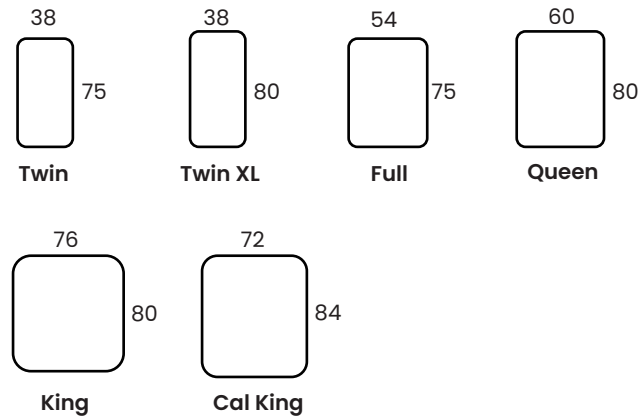



HIGHRISE™ HD | 18"

BED FRAME

- Eliminates the need for a box spring
- 17 inches of under-bed clearance for additional storage space
- Folded and boxed for easy storage and transport
- No assembly required
- New locking mechanism features durable construction and easier assembly
- 500-pound weight capacity

LIFETIME WARRANTY

SIZES

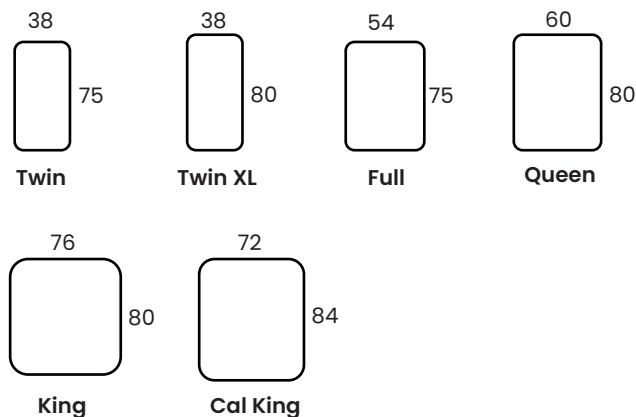



ROLLER FRAME

ADJUSTABLE BED FRAME

BED FRAME

- Features a metal frame and brushed, matte black finish
- Slatted platform provides even mattress support; no box spring required
- Sturdy steel legs and frame with 12 inches of underbed storage
- Easy assembly with all hardware included
- Fits most headboards and includes headboard slots

5 YEAR WARRANTY

SIZE

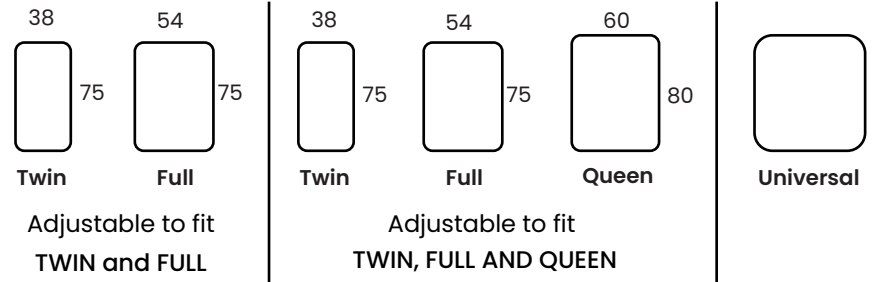

GLIDE FRAME

ADJUSTABLE CENTER SUPPORT SYSTEM

BED FRAME



- Easy assembly takes less than 10 minutes from box to bed frame
 - 100% solid steel construction
 - Adjust the leg height from 6.5 to 15.5 inches for customized fit
- 3 YEAR WARRANTY**

SIZES

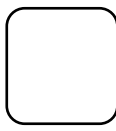

Universal





BEDROOM FURNITURE

Bedroom Furniture can take multiple forms from simply a headboard to a complete set up which includes a headboard, footboard, side rails and drawers in some models. Most every style of bedroom furniture can accept an adjustable power base. Most power bases fit within the space between the headboard, side rails and foot boards. It sits directly on the floor and has legs that bring the mattress to a good height. Any support slats included with your bedroom furniture in this case can be stored or discarded. I hope you like our collection of upholstered and wood bedroom furniture.

UPHOLSTERED HEADBOARDS

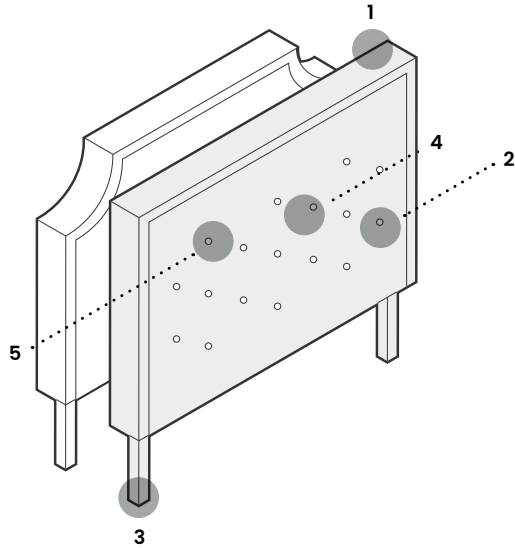

COLORS

● OA = Oat ● CH = Charcoal ● ST = Stone



KEY FEATURES

- 1 Finished Back**
Includes a discrete compartment for storage
- 2 Ultra-Plush Padding**
Added comfort
- 3 Adjustable Legs**
2-inch increments
- 4 Easy Installation**
Pre-drilled legs, modification plates, and wall mounts
- 5 Buttonless Tufting**
Geometric shape for clean, modern look

- Select between rounded or square corners
- Legs adjust headboard height from **46 to 58 inches**; mount directly to wall for any desired height

- Upholstered in 3 fabric options
- Pairs interchangeably with other upholstered bases

15 YEAR WARRANTY

MODEL# 21000 (Square)

SIZE

QUEEN

KING

CAL KING

MODEL# 21100 (Rounded)

SIZE

QUEEN

KING

CAL KING

DESIGNER HEADBOARDS

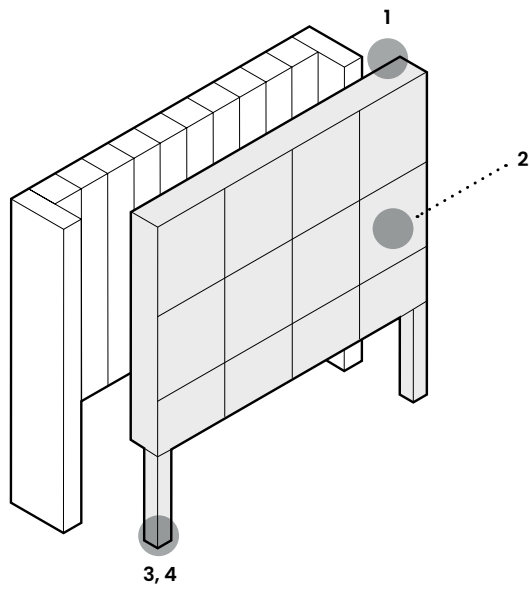

COLORS

- OA = Oat
- CH = Charcoal
- ST = Stone



- Select either designer option for an instant style upgrade
- Upholstered in 3 fabric options
- #21300 stands at 56.75 inches tall and is not adjustable, includes wings
- Pairs interchangeably with other upholstered bases
- #21200 adjusts from 49.5 to 61.5 inches; mount directly to wall for any desired height

15 YEAR WARRANTY

KEY FEATURES

- 1 Finished Back**
Includes a discrete compartment for storage
- 2 Unique Plush Padding**
Deep square tufting on the #21200 and vertical channels on the #21300
- 3 Statement Piece**
Headboards are three feet tall with added leg height
- 4 Easy Installation**
Pre-drilled legs, modification plates, and wall mounts

MODEL# 21300

- SIZE
- QUEEN
- KING
- CAL KING

MODEL# 21200

- SIZE
- QUEEN
- KING
- CAL KING

MODEL #31000

UPHOLSTERED BASE

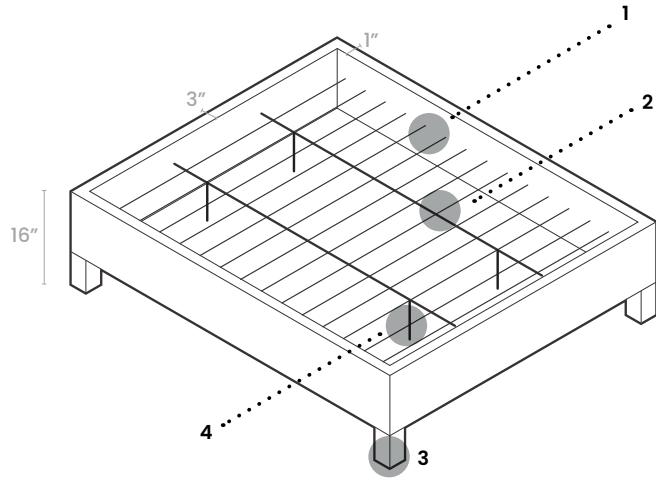

KEY FEATURES

- 1 Slat Roll**
2.9-inch slat gap ensures compatibility with all industry mattress warranties
- 2 Center Bar(s)**
Create maximum support and comfort
- 3 Corner Legs**
Sleek wood finish
- 4 Additional Legs**
Provided with center bar for additional stability

COLORS

- OA = Oat
- CH = Charcoal
- ST = Stone



- This base is clean, elegant, and easy—perfect for customers who want a traditional platform bed
- Pairs interchangeably with other headboards
- Upholstered in 3 fabric options
- **Compatible** with all adjustable bases and most competitors

15 YEAR WARRANTY

SIZE

QUEEN

KING

CAL KING

MODEL #31100

UPHOLSTERED BASE

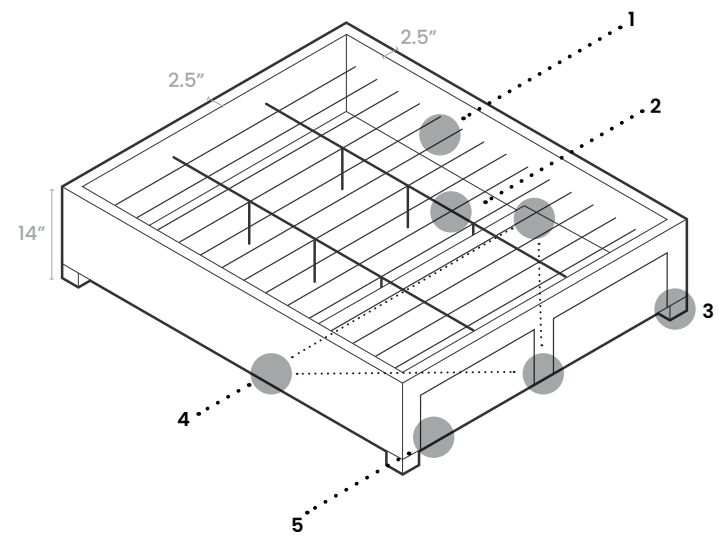

COLORS

- OA = Oat
- CH = Charcoal
- ST = Stone



KEY FEATURES

- 1 Slat Roll**
2.9-inch slat gap ensures compatibility with all industry mattress warranties
- 2 Center Bar(s)**
Create maximum support and comfort
- 3 Corner Legs**
Sleek wood finish
- 4 Support Legs**
Additional legs on drawer unit offer extra stability
- 5 2 Drawers**
Preassembled drawers attached to footboard for stylish underbed storage

- Two large drawers maximize space to create stylish underbed storage that maneuvers easily on glides
- Drawers come preassembled and attached to footboard for easy assembly
- Slats sit flush with top of base
- Upholstered in 3 fabric options
- Compatible with zero-clearance adjustable bases

15 YEAR WARRANTY

- SIZE
- QUEEN
 - KING
 - CAL KING

MODEL #31200

UPHOLSTERED BASE

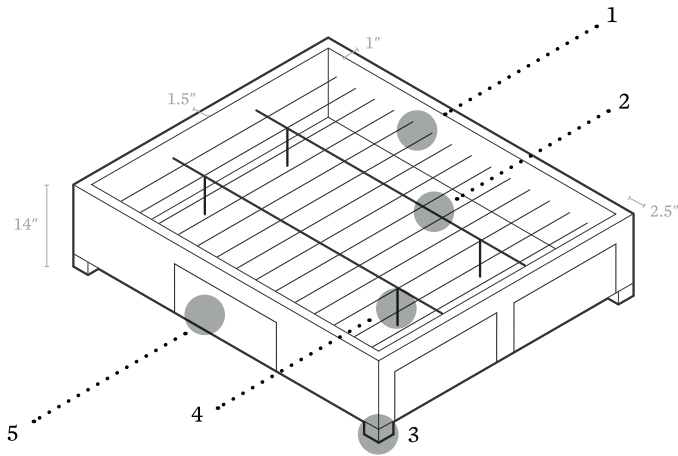

COLORS

● OA = Oat ● CH = Charcoal ● ST = Stone



KEY FEATURES

- 1 Slat Roll**
2.9-inch slat gap ensures compatibility with all industry mattress warranties
- 2 Center Bar(s)**
Create maximum support and comfort
- 3 Corner Legs**
Sleek wood finish
- 4 Additional Legs**
Provided with center bar for additional stability
- 5 4 Drawers with wheels**
Quick assembly and easy storage with caster wheels for hassle-free access

- Four large underbed drawers maneuver easily on wheels and provide subtle storage
- Upholstered in 3 fabric options
- Compatible with zero-clearance adjustable bases

15 YEAR WARRANTY

SIZE

QUEEN

KING

CAL KING

MODEL #41000

PLATFORM BED







- Features wingback headboard with diamond tufting and plush padding
- Sturdy wood frame with linen-like fabric and metal center support
- Slat roll provides even mattress support; no box spring needed
- Easy assembly with all hardware included
- Conveniently ships in a single box

2 YEAR WARRANTY

SIZE

TWIN	KING
TWIN XL	CAL KING
FULL	
QUEEN	

COLORS

CO — COBALT		PE — PEARL	
CH — CHARCOAL		ST — STONE	



MODEL #41100

PLATFORM BED





- Features buttonless square tufting and plush padding on the headboard
- Easy assembly with all hardware included
- Sturdy wood frame with linen-like fabric and metal center support
- **2 YEAR WARRANTY**
- Slat roll provides even mattress support; no box spring needed



SIZE

TWIN	KING
TWIN XL	CAL KING
FULL	
QUEEN	

COLORS

CO — COBALT		PE — PEARL	
CH — CHARCOAL		ST — STONE	
FM — CAMEL FAUX LEATHER			

MODEL #41300

PLATFORM BED WITH DRAWERS



- Features diamond tufting and plush padding on the headboard
- Sturdy wood frame covered with linen-like fabric
- Two easy-glide drawers allow for extra storage
- Slat roll provides even mattress support; no box spring needed
- Easy assembly with all hardware included

2 YEAR WARRANTY

SIZE



FULL

QUEEN

KING

CAL KING

COLORS

ST – STONE		PE – PEARL	
CH – CHARCOAL			

STOWE BED

PLATFORM BED WITH DRAWERS

PLATFORM BED

With rounded, tapered legs inspired by mid-century modern design



DW = Driftwood



CS = Chestnut

Queen 65" x 48"

King 81" x 84"

Full 57" x 79"

Twin 42" x 79"

CRAFTSMANSHIP

Made of solid Mango wood

Inspired by mid-century modern design

Natural finish highlights the beautiful wood grain

Backed by the **Salt Flat Guarantee**



DIMENSIONS

Available in Chestnut

Due to natural material variations, each piece is unique



CARE

Dust with a soft, dry cloth

Wipe spills immediately to prevent staining



REASONS TO LOVE

Clean lines and a simple design create a timeless look

Solid wood construction is durable and strong

Elegant wood grain adds visual appeal



STOWE COLLECTION

DRESSER, SMALL CHEST, NIGHTSTAND

DRESSER

A six-drawer chest with wood glides and tapered legs inspired by mid-century modern design.

Dresser 60" x 36" x 18"



SMALL CHEST

A three-drawer chest inspired by mid-century modern design with wood glides and tapered legs.

Small Chest 36" x 36" x 18"



DESK (FOB ONLY):



NIGHTSTAND

A mid-century modern inspired nightstand with two draw storing.

Nightstand 28" x 30" x 15"

CRAFTSMANSHIP

Made of solid Mango wood

Inspired by mid-century modern design

Natural finish highlights the beautiful wood grain

Backed by the **Salt Flat Guarantee**



DETAILS & DIMENSIONS

Available in Chestnut and Driftwood

Due to natural material variations, **each piece is unique**



CARE

Dust with a soft, dry cloth

Wipe spills immediately to prevent staining

Do not place dresser over air conditioning or heating vents



REASONS TO LOVE

Clean lines and a simple design create a timeless look

Solid wood construction is durable and strong

Elegant wood grain adds visual appeal



PILLOWS

Choosing the correct pillow is another crucial part of your sleep experience. Rarely is there a pillow that is one size fits all. I am not even referring to personal preferences of firm, soft, fluffy etc. I am speaking more about the unique width of a persons shoulders comparing a small to tall person. The distance between your head and your sleeping side shoulder, (if you are a side sleeper) is very important to proper neck support. As with proper spinal alignment you get with a supportive mattress, it's best if your neck is properly aligned also. To achieve this you need a pillow that fits your sleeping style whether you're a side, back or stomach sleeper.



PILLOWS



CARBON COOL™ OMNIPHASE™ PILLOW

- Infused with activated carbon and phase change material for constant temperature regulation that maintains the body's optimum sleep temperature
- Surface coated with OmniPhase™ phase change material, an advanced cooling technology that continuously absorbs and dissipates heat
- Ventilated for increased airflow and breathability
- Shoulder cutout shape ideal for side sleepers; non-mesh Tencel™ Lyocell fabric cover
- Activated carbon infused in the foam creates pathways that move heat away from the head and neck
- Soft, supportive memory foam relieves pressure points
- Tencel™ Lyocell mesh removable cover with superior moisture-management properties aids in optimal sleeping temperatures

5 YEAR WARRANTY

Pillow

Queen

King

Shoulder Pillow

Queen

King





AROMATHERAPY ZONED DOUGH™ PILLOW

- Dough™ formula, infused with aromatherapy oil, creates softer, more supportive memory foam
- Tencel™ Lyocell mesh removable cover with superior moisture-management properties aids in optimal sleeping temperatures
- Included 3ml aromatherapy spray helps boost and maintain scent
- Shoulder cutout shape ideal for side sleepers
- Zoned Technology™ design cradles the head while supporting the neck
- Ventilated for increased airflow and breathability
- Peppermint is known to promote clarity of mind and healthy respiratory function
- Lavender is known to promote calming, relaxing, and rejuvenating sleep

5 YEAR WARRANTY



Infusions

- Peppermint
- Lavendar

Pillow

- Queen
- King

Shoulder Pillow

- Queen
- King

Aromatherapy Spray

SIZE	
3ml Spritzer (included)	●
60ml Spritzer	●





ZONED DOUGH™ + BAMBOO CHARCOAL PILLOW

- Infused with bamboo charcoal to help regulate humidity, temperature, and odors
- Tencel™ Lyocell removable cover with superior moisture-management properties aids in optimal sleeping temperatures
- Zoned Technology™ design cradles the head while supporting the neck
- Shoulder cutout shape ideal for side sleepers
- Ventilated for increased airflow and breathability
- Dough™ formula creates a softer, more supportive memory foam

5 YEAR WARRANTY

Mid Loft Pillow

Queen

King

Shoulder Pillow

Queen

King





ZONED GEL DOUGH™ PILLOW

- Gel Dough™ formula creates a cooler, softer memory foam
- Ventilated for increased airflow and breathability
- Tencel™ Lyocell removable cover with superior moisture-management properties aids in optimal sleeping temperatures
- Zoned Technology™ design cradles the head while supporting the neck
- Shoulder cutout shape ideal for side sleepers

5 YEAR WARRANTY



High Loft Pillow

Queen

King

Mid Loft Pillow

Queen

King

Low Loft Pillow

Queen

King

Shoulder Pillow

Queen

King



PILLOWS GEL MEMORY FOAM

WITH REVERSIBLE COOLING COVER

- Reversible cover: cool on one side, neutral on the other
- Soft cover is removable and machine washable
- Gel-infused memory foam offers temperature-regulating comfort and support
- Cooling side dissipates body heat

3 YEAR WARRANTY

SIZE

STANDARD

QUEEN

KING



PILLOWS

GEL MEMORY FOAM



- Gel-infused memory foam offers temperature-regulating support and comfort
- Soft cover is removable and machine washable
- Memory foam provides superior pressure point relief
- Ventilated for improved airflow and breathable comfort

3 YEAR WARRANTY

SIZE

STANDARD

QUEEN

KING





PILLOWS

SHREDDED MEMORY FOAM

- Shredded memory foam is soft and moldable
- Consistent filling does not shift or clump
- Smooth polyester cover
- Piped edges and gusseted design add lasting style

1 YEAR WARRANTY



ONE PACK

SIZE

QUEEN

TWO PACK

SIZE

QUEEN



TRIPLELAYER™ DOWN PILLOW

- Luxuriously soft, supportive, and natural
- Ethically harvested down clusters and feathers
- 90% down top and bottom layer
- Breathable percale weave cover
- 90% feather supportive inner core
- 100% natural unbleached, undyed cotton cover

3 YEAR WARRANTY



SIZE

QUEEN

KING



ZONED TALALAY LATEX PILLOW

- 100% natural Talalay latex with no synthetic additives
- 100% natural cotton removable cover offers a crisp, clean, and breathable pillow surface
- Zoned Technology™ design cradles the head while supporting the neck
- Ventilated for increased airflow and breathability

5 YEAR WARRANTY

High Loft Pillow

SIZE

Queen Plush

Queen Firm

King Plush

King Firm

Low Loft Pillow

SIZE

Queen Plush

Queen Firm

King Plush

King Firm





A



B



C



D

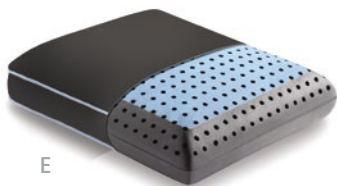

E



G



H



I

TRAVEL PILLOWS

TRAVEL PILLOW

- All the benefits of your favorite Malouf™ pillow in a convenient travel size
- Available in a variety of materials and covers
- Smaller size great for easy packing

SIZE

A. *Dough™*

B. *Shredded Gel Dough™*

C. *Zoned Dough™ + Lavender*

D. *Gel Dough™ + Z™ Gel*

E. *CarbonCool™ + OmniPhase™*

TRAVEL NECK PILLOW

- All the benefits of your favorite Malouf™ pillow in a convenient travel size
- Available in a variety of materials and covers
- Wraps around the neck for total support

SIZE

G. *Shredded Gel Dough™*

H. *Zoned Dough™ + Lavender*

I. *Gel Dough™ + Z™ Gel*



BED LINENS & ACCESSORIES

Your bed linens or sheets are also an important part of getting a rejuvenating nights rest. While this is more preference related than technical, it is important that you feel comfortable in the sheets you choose as this will translate to your brain as a good thing which will help you relax when you go to bed. Sheets have come a long way from the past where the main choice was cotton. Now there are COTTON, MICRO-FIBER, TENCEL™ and performance sheets from SHEEX®. As far as accessories we have also included a foam topper to help provide more comfort to a mattress, but shouldn't be used to try and revive an older unsupported mattress. We also have a down alternative topper which is similar to what many hotels use these days. Finally a new mattress is not complete without a good mattress protector to help preserve your investment from spills, pet accidents and dust mites.



DOUBLE-BRUSHED MICROFIBER SHEET SET

- 100% microfiber polyester
- Double-brushed for extra softness
- Deep pocket with elastic fits mattresses up to 14 inches deep
- Fabric is soft and easy to care for; dry on low heat
- Set includes a fitted sheet, flat sheet, and pillowcase(s)

3 YEAR WARRANTY



PREMIER TENCEL™ LYOCELL SHEET SET

- 100% Tencel™ Lyocell made in an eco-friendly and mattresses up to closed loop process
- Sateen weave and soft to care for; fabric create a lustrous and silky-smooth feel
- Temperature regulating fibers wick away extra moisture
- Deep pocket with elastic fits mattresses up to 18 inches deep
- Fabric is soft, strong, and easy to care for; dry on low heat
- Set includes a fitted sheet, flat sheet, and pillowcase(s)

3 YEAR WARRANTY

600 THREAD COUNT COTTON-BLEND SHEET SET



- 600-thread-count with a blend of 52% cotton, 42% polyester, and 5% lyocell
- Fabric is easy to care for and wrinkle resistant; dry on low heat
- Sateen cross weave with the softness of cotton and the performance of polyester
- Set includes a fitted sheet, flat sheet, and pillowcase(s)
- Deep pocket with elastic fits mattresses up to 14 inches deep

3 YEAR WARRANTY



SIZE	
TWIN	KING
TWIN XL	SPLIT KING
FULL	CAL KING
QUEEN	SPLIT CAL KING (WHITE)
SPLIT QUEEN (WHITE)	

COLORS	
SA — TAN	WH — WHITE
SL — GRAY	



ELEVATED PERFORMANCE

SHEET SET

Our Ridiculously Soft® **SHEEX fabrics** breathe 10x better than traditional cotton sheets, allowing air to circulate freely around your body to maintain an ideal sleep temperature. Our technical fibers wick moisture away from your skin 2x-3x better than cotton and facilitate faster evaporation, making sure you don't wake up damp or sweaty.

In addition, **SHEEX Elevated Performance** sheets stretch and conform to your mattress, achieving an exceptional fit on mattresses of all sizes. Plus, these patented sheets are wrinkle resistant with a luxurious drape and sheen, requiring minimal care.

We guarantee SHEEX will be the best sheets you'll ever own.



Ridiculously Soft



Temperature Controlling



Breathable



Moisture Wicking



Wrinkle Free



Stay-Fit Corners



Perfect For Adjustable Base

SIZE

TWIN / TWIN XL

KING

FULL

CAL KING

QUEEN

COLORS



Bright White



Ecu



Sage Mist



Pearl Blue



Navy



Graphite



Black



LINEN-WEAVE COTTON SHEET SET

- Casual, linen-like look made from 100 percent cotton
- Open percale weave is light and airy for extra breathable feel
- Cotton fibers are soft, strong, and naturally hypoallergenic
- Cotton fibers are soft, strong, and naturally hypoallergenic
- **Universal Fit™** elastic and extra-deep pockets provide secure fit for mattress depths 6 to 14 inches
- Sheet set includes pillowcase(s)

SIZE

TWIN	KING
TWIN XL	SPLIT KING
FULL	CAL KING
QUEEN	SPLIT CAL KING
SPLIT QUEEN	

PILLOWCASE SET

QUEEN (SET OF 2)

KING (SET OF 2)

COLORS

- WH = White
- FG = Fog
- SA = Sand
- SG = Sage





2.5" GEL MEMORY FOAM

MATTRESS TOPPER

- 2.5-inch thick gel-infused memory foam offers superior cooling
- Removable rayon from bamboo cover
- Ventilated to increase airflow and regulate sleeping temperature
- Soft, supportive consistency quickly conforms to the body

3 YEAR WARRANTY



MATTRESS TOPPER

SIZE

TWIN

KING

TWIN XL

CAL KING

FULL

QUEEN

3" DOWN ALTERNATIVE TOPPER

MATTRESS TOPPER

- Down-alternative filling adds a soft layer to any mattress without odors, allergens, or sharp quills associated with down and feathers
- 250-thread-count pure cotton percale cover offers a crisp, clean, and breathable surface
- Baffle-box construction keeps fill from clumping or shifting
- Thick elastic anchor bands secure topper at mattress corners

3 YEAR WARRANTY



MATTRESS TOPPER

SIZE

TWIN

KING

TWIN XL

CAL KING

FULL

QUEEN





FIVE 5 SIDED™ SMOOTH MATTRESS PROTECTOR

- Plush, hypoallergenic fabric sleeps comfortably without changing the feel of the mattress
- Fitted sheet design features elastic that ensures a secure fit for mattress depths 6 to 22 inches
- Quiet and breathable laboratory-certified H2Pro™ membrane is liquid proof and dust mite proof
- Top and side mattress protection

15 YEAR WARRANTY

MATTRESS PROTECTOR

SIZE

TWIN	KING
TWIN XL	SPLIT KING
FULL	CAL KING
QUEEN	SPLIT CAL KING (WHITE)
SPLIT QUEEN (WHITE)	

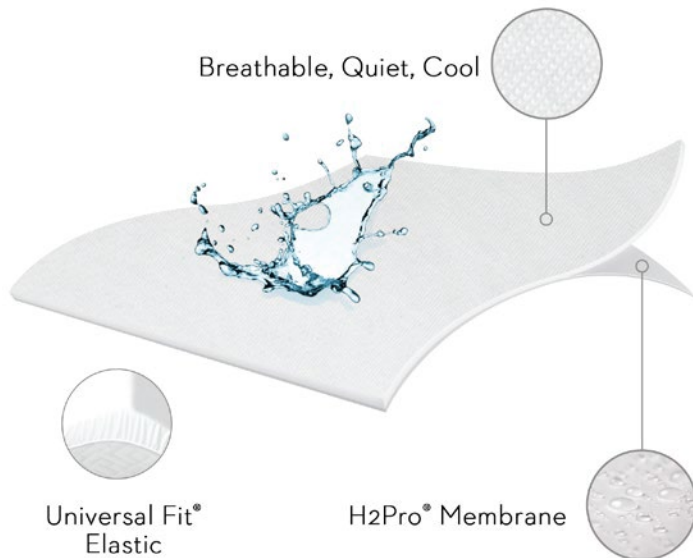



ENCASE™ HD

MATTRESS PROTECTOR

- Laboratory-certified Micro Tite™ 360° zipper closure blocks bed bugs; easily removable for laundering
 - Quiet and breathable laboratory-certified H2Pro™ membrane is liquid proof and dust mite proof
 - Inner elastic along bottom guarantees a smooth, secure fit for mattress depths 6 to 22 inches
 - Patented complete encasement mattress protection
- 15 YEAR WARRANTY**

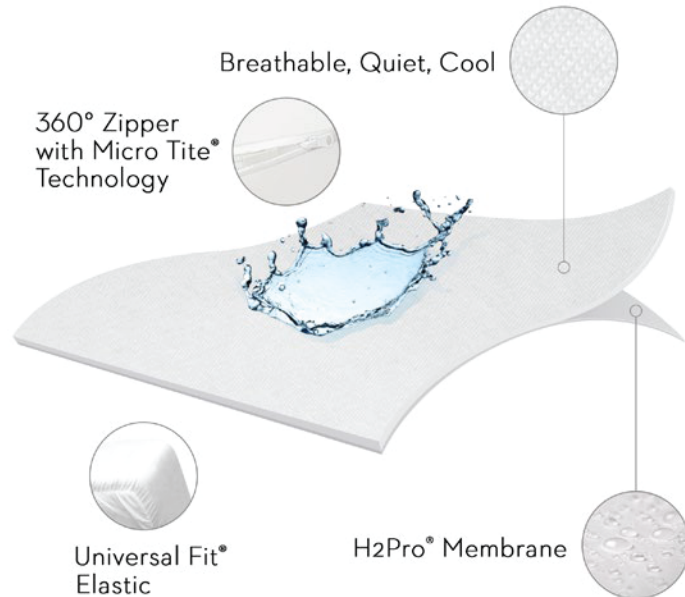

MATTRESS PROTECTOR

SIZE

TWIN	KING
TWIN XL	SPLIT KING
FULL	CAL KING
QUEEN	SPLIT CAL KING (WHITE)
SPLIT QUEEN (WHITE)	

SEATING

We hope you like our collection of sofas, chairs and sofa beds. Our sofa beds come in 2 styles with 6 different colors to choose from. This style of sofa bed is much easier to convert from sitting to sleeping versus the traditional sofa bed style. We will be expanding our seating offerings in the coming months, so please check on our website for the most up to date selections.



SEATING



#45000



ACCENT CHAIR

- Transitional style with square-arm design
- Finished in stain-resistant linen-like fabric
- Solid, durable rubberwood frame
- Plush seat and back cushions
- Easy assembly with all hardware included
- Conveniently ships in one box

1 YEAR WARRANTY



COLORS

CHARCOAL		CREAM	
NAVY			

	LENGTH	WIDTH	HEIGHT
CHAIR	29.5"	25.5"	32"



#45100



BARREL CHAIR

- Transitional style barrel chair
- Arrives pre-assembled, aside from attaching legs
- Features diamond tufting on faux leather upholstery
- Conveniently ships in one box
- Solid wood frame and legs
- Compact size to fit into any space

1 YEAR WARRANTY



COLORS

FK – BLACK FAUX LEATHER		FG – GRAY FAUX LEATHER	
FC – CAMEL FAUX LEATHER			

	LENGTH	WIDTH	HEIGHT
BARREL CHAIR	28"	29"	31"



#55000







SOFA

- Contemporary style with buttonless tufting and square arm
- Easy assembly with all hardware included
- Finished in faux leather, fabric, or velvet upholstery
- Conveniently ships in one box
- Sturdy wood frame and legs
- Removable, plush cushions

1 YEAR WARRANTY



COLORS

FK – FAUX BLACK LEATHER		LG – LIGHT GRAY	
CH – CHARCOAL		NV – NAVY	
VU – VELVET GREEN		VN – VELVET NAVY	
FM – CAMEL FAUX LEATHER			

	LENGTH	WIDTH	HEIGHT
SOFA	76"	33"	35.5"



#55100





SOFA

- Transitional style sofa with curved arm
- Finished in upholstered fabric or faux leather
- Sturdy wood frame and legs
- Removable cushions with thick memory foam and zippered covers
- Easy assembly with all hardware included
- Conveniently ships in single box

1 YEAR WARRANTY



COLORS

GR – GRAY		FK – BLACK FAUX LEATHER	
CH – CHARCOAL		FM – CAMEL FAUX LEATHER	

	LENGTH	WIDTH	HEIGHT
SOFA	73"	33"	35"



#55200



SOFA

- Traditional style with rolled arm
- Finished in linen-like fabric
- Sturdy wood frame and legs
- Removable, plush cushions
- Easy assembly with all hardware included
- Conveniently ships in two boxes

1 YEAR WARRANTY



COLORS

NV – NAVY		LG – LIGHT GRAY	
CH – CHARCOAL			

	LENGTH	WIDTH	HEIGHT
SOFA	87"	35"	37"



#55300





SOFA

- Features square-tufted cushions with a scooped arm
- Conveniently ships in a single box
- Finished in faux leather or woven fabric
- Removable memory foam cushions and zippered covers
- Easy assembly with all hardware included

1 YEAR WARRANTY



COLORS

FC – CAMEL FAUX LEATHER		GR – LIGHT GRAY	
CH – CHARCOAL		FK – BLACK FAUX LEATHER	
NV – NAVY			

	LENGTH	WIDTH	HEIGHT
SOFA	75.5"	33"	35.5"

#75100

SOFA BED









- Features buttonless tufting for modern styling
- Easily converts from **seating to sleeping position** in a few clicks
- Finished in faux velvet, faux leather, or linen-like polyester upholstery
- Sturdy wood frame and metal legs
- Easy assembly with all hardware included
- Conveniently ships in one box

1 YEAR WARRANTY



COLORS

FB – BROWN FAUX LEATHER		CH – CHARCOAL	
FK – BLACK FAUX LEATHER		VU –VELVET NAVY	
LG – LIGHT GRAY		VN – VELVET GREEN	

	LENGTH	WIDTH	HEIGHT
SOFA BED	74"	34"	30"



#75500







SOFA BED

- Features box tufting for modern styling
- Easily converts from seating to sleeping position in a few clicks
- Finished in faux velvet, faux leather, or linen-like polyester upholstery
- Sturdy wood frame and metal legs
- Easy assembly with all hardware included
- Conveniently ships in one box

2 YEAR WARRANTY



COLORS

FB – BROWN FAUX LEATHER		CH – CHARCOAL	
FK – BLACK FAUX LEATHER		VU –VELVET NAVY	
LG – LIGHT GRAY		VN – VELVET GREEN	

	LENGTH	WIDTH	HEIGHT
SOFA BED	82"	36"	32"



RBA

RELIEF BED WHOLESALERS

www.reliefbedwholesale.com